



Garden Cloche Instruction Manual

G4798







General information and safety warnings

- Never overload your cloche.
- Keep your plants watered and check on them daily.
- Do not allow children to play in or on the cloche.
- Do not load on top of the cloche.
- Assemble on a flat, level surface.
- Never drag the cloche, always move by carrying equally between two people.
- Not suitable for commercial purposes.

Care and maintenance

- To prolong the life of the cloche, periodically wipe clean the frame with a soft, damp cloth.
- The cloche is designed to protect young seedlings or cover vegetables and flowers to extend the growing season.
- Find a sunny yet sheltered location in your garden to place your cloche.
- Check plants in your cloche daily, keep your plants watered.
- Ventilation is important; even in early spring heat may build up quickly in the cloche. Remember to open the cloche to allow ventilation.
- Remember to close the frame during the evening and overnight to protect young and delicate plants from frosts.

Parts list

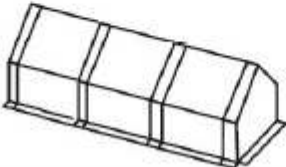
NO	PART	QTY
1		8
2		17
3		8
A		6
B		2
D		4
E		8
F		1

Assembly

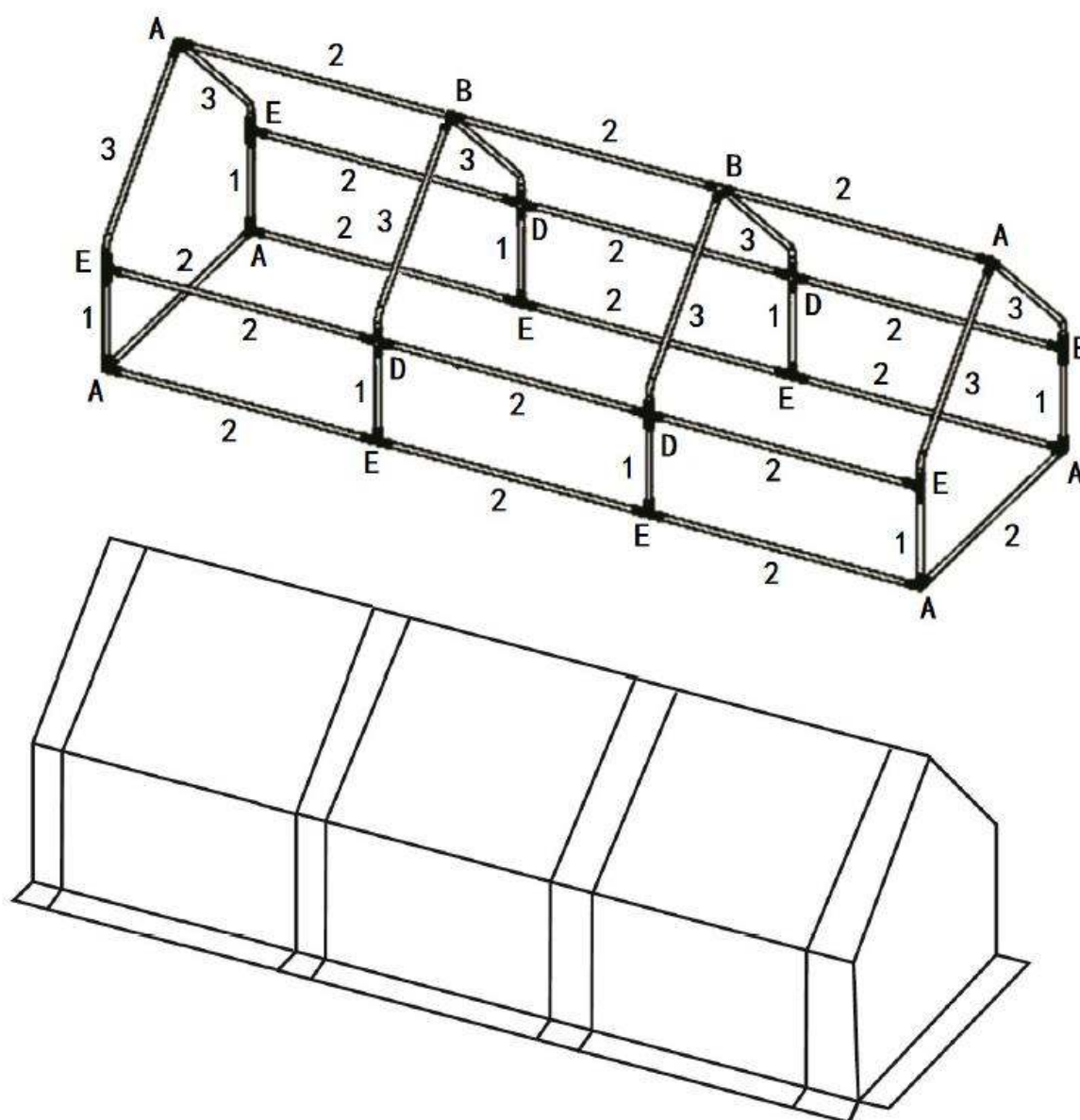

GUARANTEE

IMPORTANT

**Please do not return this product without first calling the Customer Service number below:
0871 911 7031***

Thank you for purchasing this product, which has been made to demanding high quality standards and is guaranteed for domestic use against manufacturing faults for a period of 12 months from the date of purchase.

Register your product for an extended 2-year warranty by visiting our website www.gardengearonline.co.uk. The product must be registered, along with your contact information, within 30 days of purchase. For full terms and conditions please visit our website.

This guarantee does not affect your statutory rights. If your product fails due to a defect in material or workmanship during this period, please return it to the place of purchase. Normal wear and tear is not covered under the guarantee.

Any guarantee is invalid if the product has been misused or subject to neglect or an attempted repair other than by our own service centre.

Due to continuous product improvement, we reserve the right to change the product specification without prior notice.

After Sales Customer Service:

Customer Service Department, Branded Garden Products Ltd, Premier House, Hortonwood 7, Telford, TF1 7GP

Telephone: 0871 911 7031*

E-mail customerservice@gardengearonline.co.uk

Please retain for future reference.
Colours and contents may vary.

Calls cost 13p per minute, plus your phone company's access charge.