

G4792 6 x 6 Foot PE Cover Shed Instruction Manual

For correct usage, please read these instructions carefully before use and keep in a safe place for future reference.













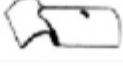

General Information and Safety Warnings

- Remove all packaging and make sure that the product is intact. Do not leave packaging materials like bags and staples within the reach of children and pets.
- Only use the product for its intended purpose.
- The manufacturer is not responsible for any eventual damages caused by improper or faulty use.
- Do not use any open flames inside or near the shelter.
- Always check for overhead electric wires, tree branches or other structures before installing the shed. Be aware of anything that could cause rainwater to run off onto the shed.
- Do not store any flammable liquids inside the shed.
- Do not hang anything from the roof or supporting frame.
- Always take the cover off and store away safely if severe weather is forecast.
- Make sure that your shed is securely anchored to the ground, you are responsible for the shed and ensuring it doesn't become unanchored. Periodically check the anchoring is still sufficient.
- The shed is not designed to be a permanent structure.
- Remove any gathered snow or rainwater immediately from the cover, this will help prolong the life of your shed.
- Never use hard-edged tools (such as a shovel) to remove something from the fabric of the shed.
- Not suitable for commercial purposes.
- At least two people are required to build this item and two sets of steps are necessary.
- Until the bracing pieces and purlins are fitted, make sure that the upper section of the arches are held firmly together so that they do not detach.

Care and maintenance

- Always make sure that the cover remains tight over the frame.
- Remove any gathered snow or rainwater from the roof with a soft-bristled instrument (such as a mop).
- Spot clean with a soft, damp cloth as needed.
- Do not use bleach or any harsh abrasive products to clean the fabric.
- Remove the cover and store away if severe weather is forecast.

Parts List

PART LIST			
PART CODE	Description		Qty (PC)
1	Roof tube		4
2	T-tube		3
3	Leg tube		4
4	Base tube		2
6	Base tube		4
B	Three way connector		6
D	Brace part 1		8
F	Pegs		4
I	Plastic marbles		28
G	Tool		2
H	Bolt M6x45mm		4
12	Rear cover		1
14	Door cover		1
J	Roof cover		1
K	Roof Fastener (winch system)		4

Assembly

- Remove all parts from box and dispose of all packaging correctly.
- Check that you have all the parts listed before starting.
- Assemble the shed on a flat level surface.
- We recommend that 2 people assemble this shed.
- Assemble it where you intend to place it.

Arches and Purlins Installation

Step 1

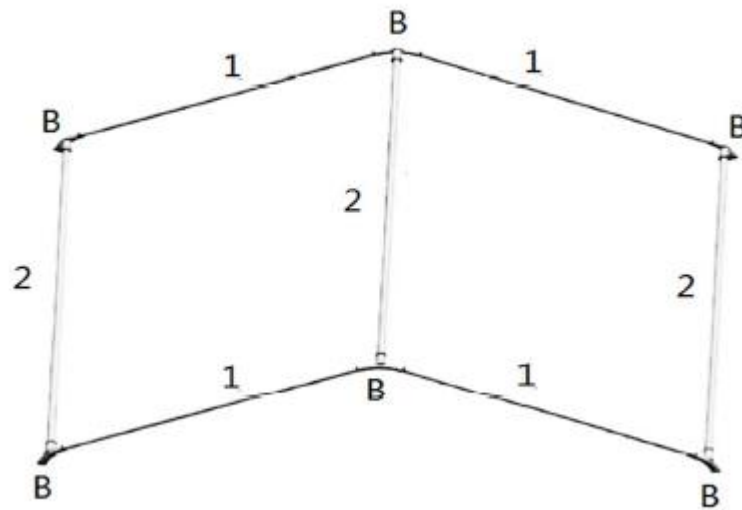

Step 2

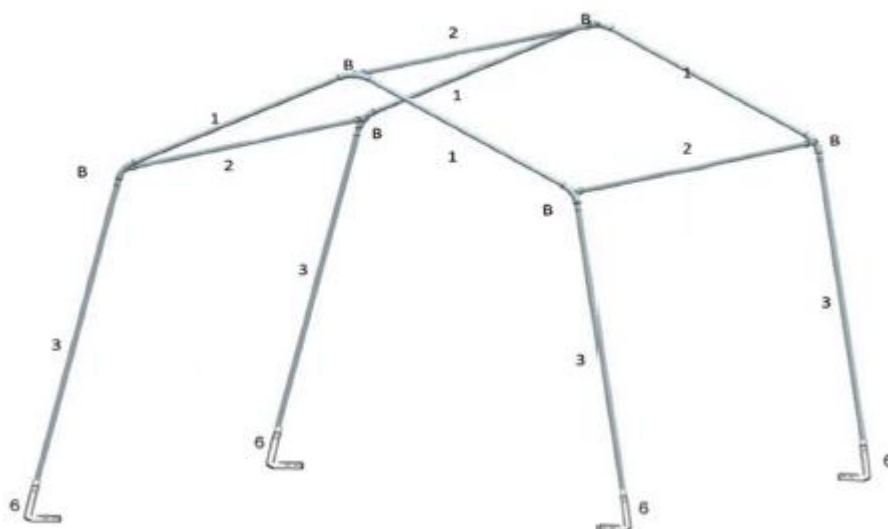

Step 3

Attach the roof cover J onto the frame as shown, then insert tube (4) through the sleeve at the base of the cover. Connect both ends to parts 3, with brace part D and bolt H, see Figure A.

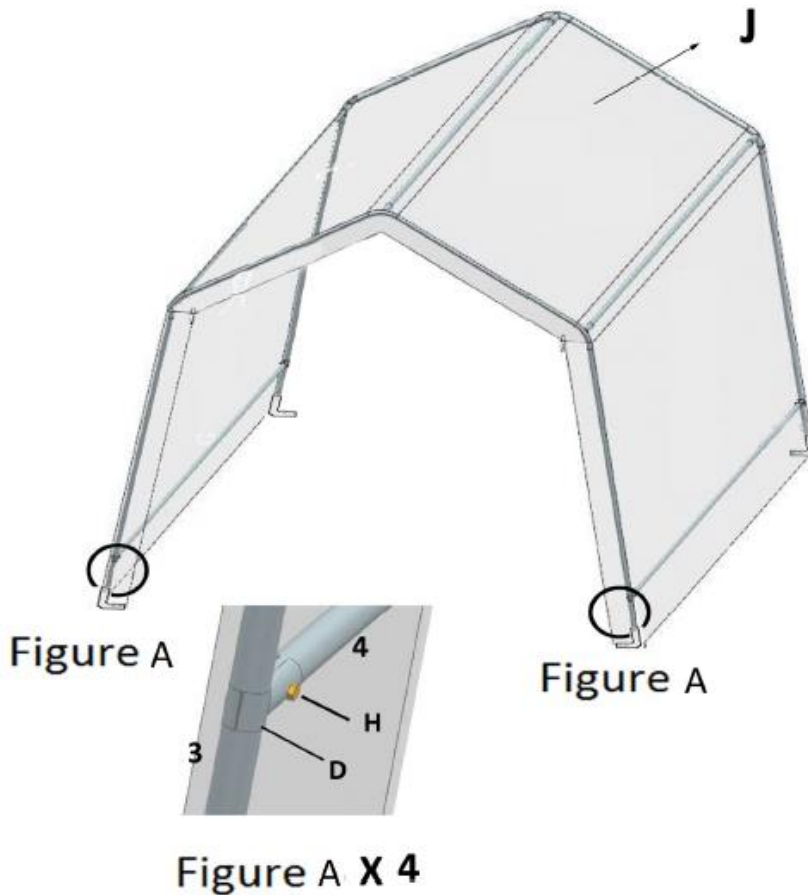

Step 4

Fit rear cover, part 12 and door, part 14 using the plastic marbles. Connect and fit parts 6 base tube to each leg, part 3. Secure with pegs F, see Figure B.

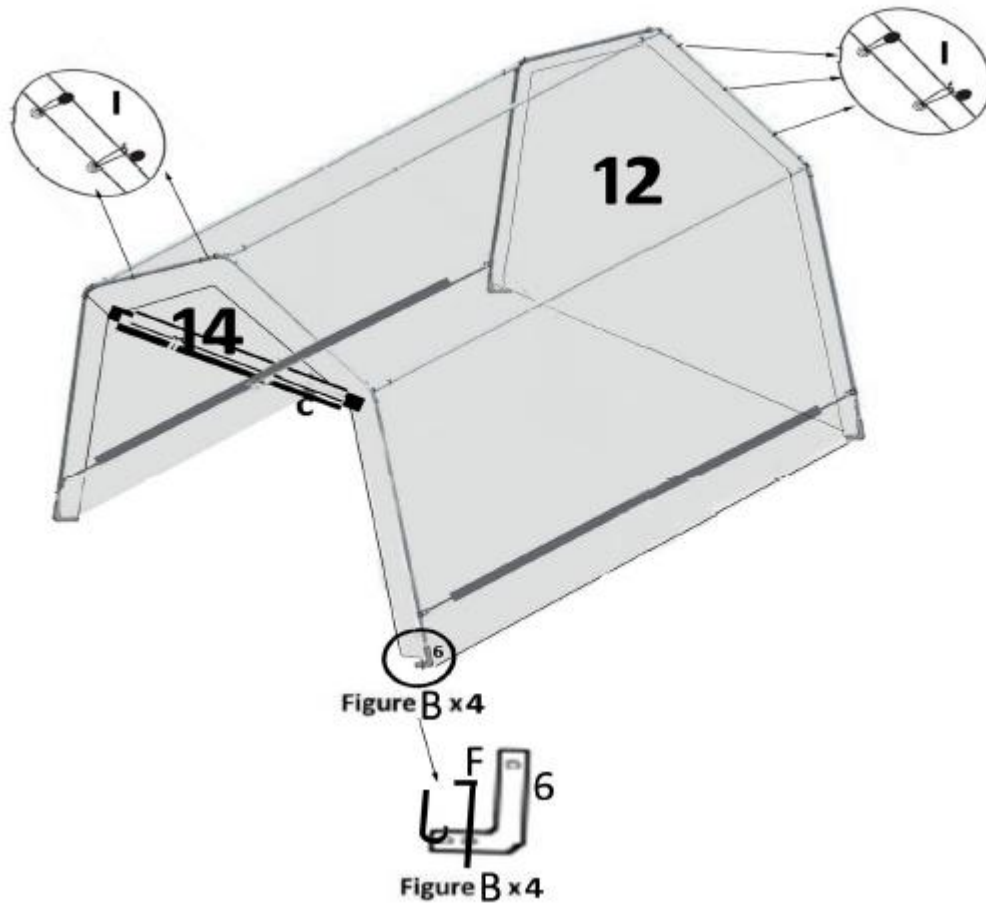

TOP TIP: Place the four bottom corners of the front and rear doors under the base tube to prevent it from moving:



Then secure the frame and cover by inserting the pegs to the holes on the base tubes, parts 6

Step 5 Assembling the roof fastener

1. Press 'D' to open out the handle 'B', then insert the end of the roof rope through the central hole in the middle of the fastener, see 'A' below, and adjust 'B' by moving back and forth.

Note: Do not pull the rope out of the cover completely



2. Before completely tightening, insert the hook in the hole at the end of the base tubes (6), and continue tightening the roof fastener until you have the desired tension on the roof.

Note: To avoid splitting the cover and breaking the rope, do not overtighten the rope. Ensure the load is split evenly over the rope and periodically check the cover is even at both ends of the shed as you are tightening the rope.

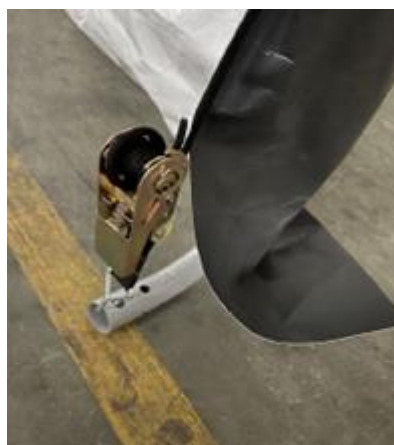
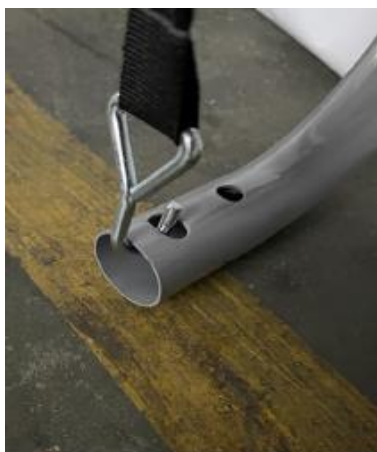

To loosen the fastener, open the handle 'B' fully, by pressing 'D', so that it is in a straight line and press and hold position C, shown below; with the other hand, pull the end of the rope.

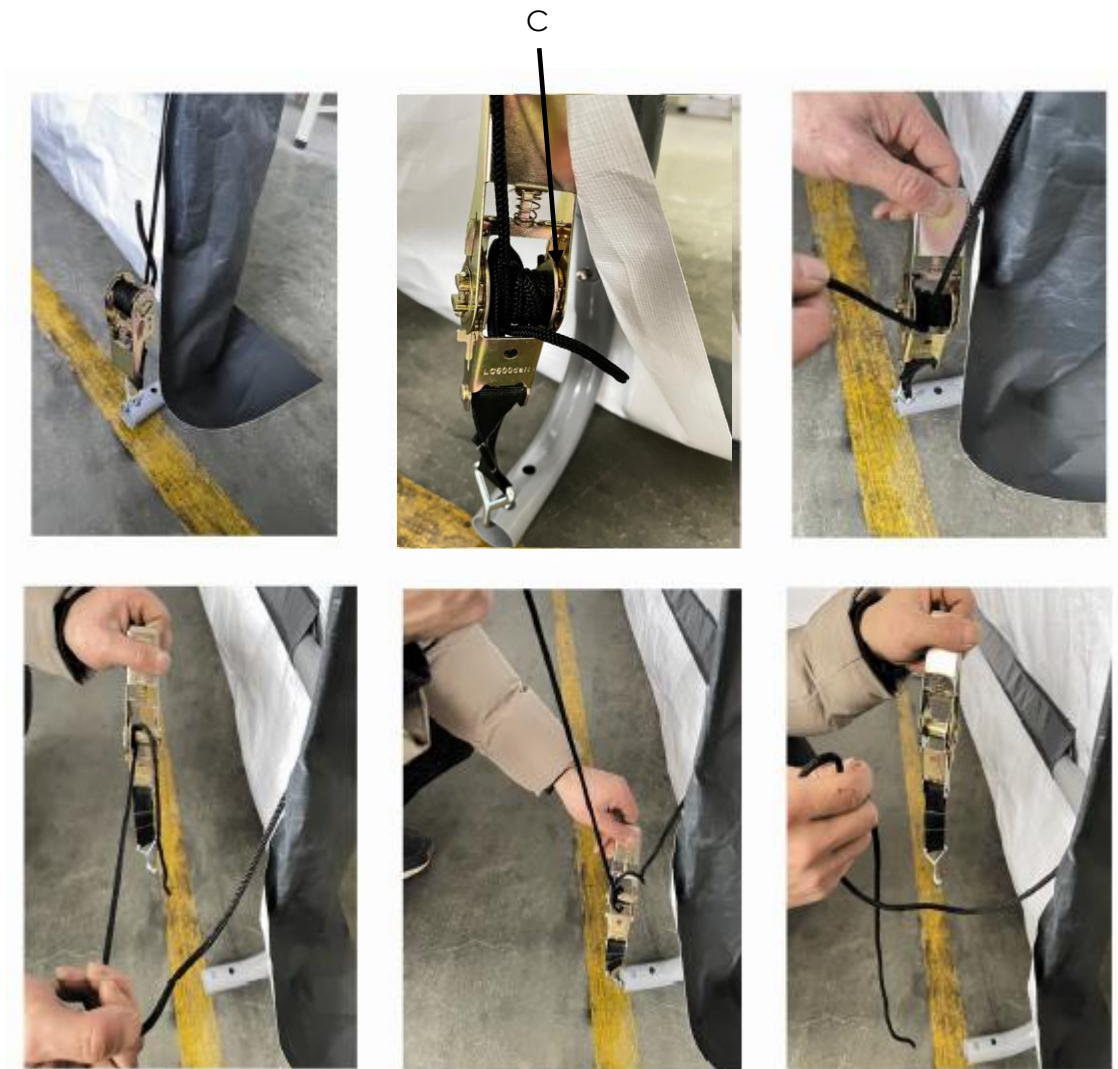

GUARANTEE

IMPORTANT

Please do not return this product without first calling the Customer Service number below:

0871 911 7031*

Thank you for purchasing this product, which has been made to demanding high quality standards and is guaranteed for domestic use against manufacturing faults for a period of 12 months from the date of purchase.

Register your product for an extended 2-year warranty by visiting our website www.gardengearonline.co.uk. The product must be registered, along with your contact information, within 30 days of purchase. For full terms and conditions please visit our website.

This guarantee does not affect your statutory rights. If your product fails due to a defect in material or workmanship during this period, please return it to the place of purchase. Normal wear and tear is not covered under the guarantee.

Any guarantee is invalid if the product has been misused or subject to neglect or an attempted repair other than by our own service centre.

Due to continuous product improvement, we reserve the right to change the product specification without prior notice.

After Sales Customer Service:

Branded Garden Products Ltd, Premier House, Hortonwood 7, Telford, TF1 7GP

Telephone: 0871 911 7031*

E-mail customerservice@gardengearonline.co.uk

Please retain for future reference.

Colours and contents may vary.

*Calls cost 13p per minute, plus your phone company's access charge