



Metal Raised Garden Bed G4789

For correct usage, please read these instructions carefully before use and keep in a safe place for future reference.

Before starting assembly, make sure that all parts are present.



General Safety and Warnings

Take care in case of sharp edges - gloves should be worn during assembly.

Hints and Tips

When you build a raised bed, make sure the entire soil surface is within arm's reach from the edge without having to step on to the soil. If you install paths between your raised beds, make sure they are at least 30cm (12in) wide for walking or 45cm (18in) wide if wheelbarrow access is required.

Parts list

NO.	IMAGE	mm	QTY
Gb-8		300	4
Gb-F2a		535	4
Gb-A3		M4x10	32

NO.	IMAGE	mm	QTY
Gb-A4		2380	1

Assembly

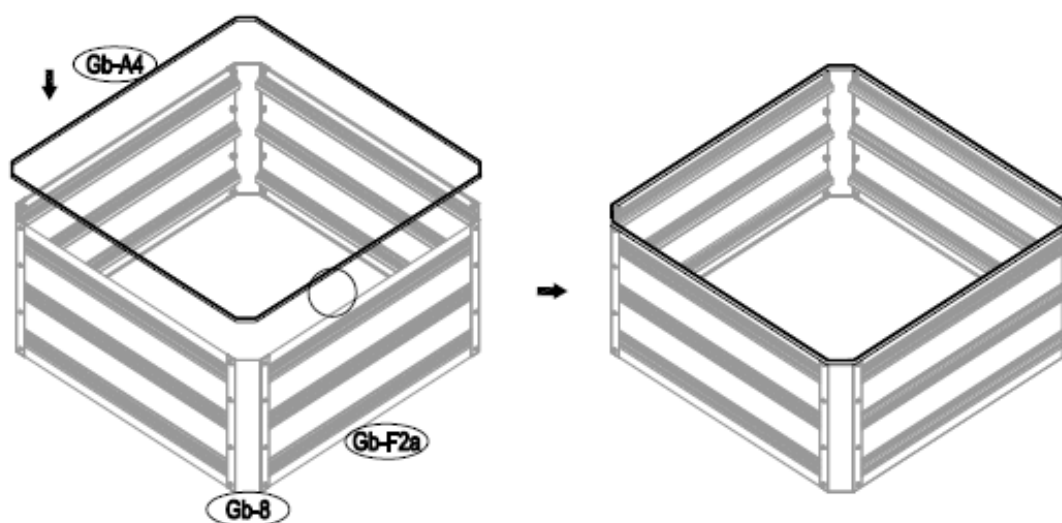
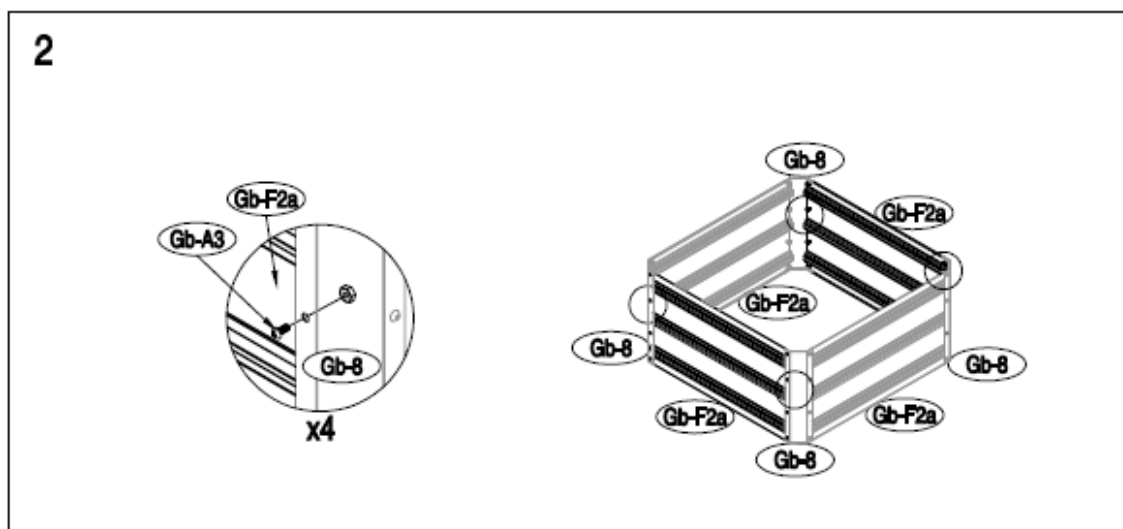
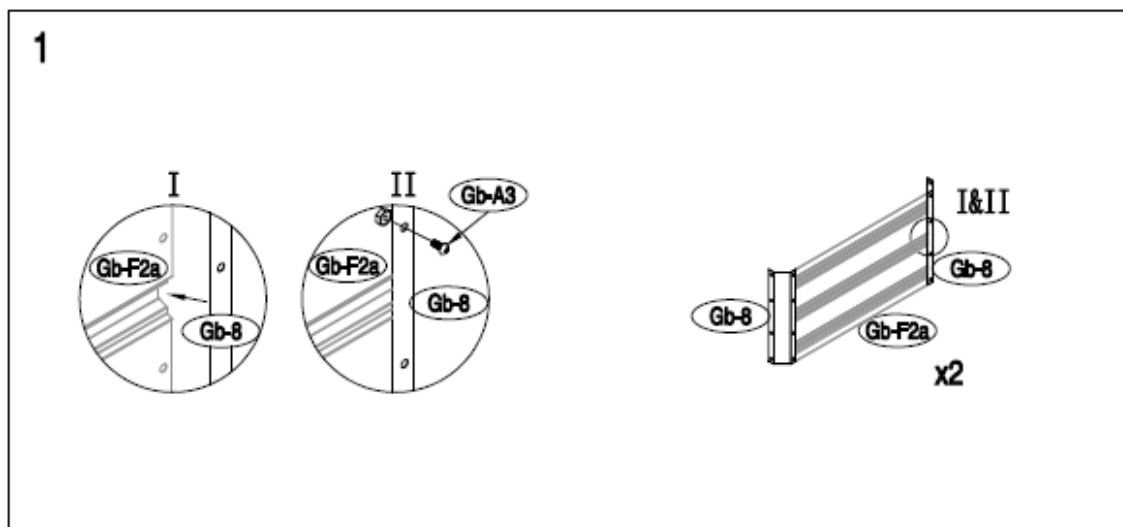

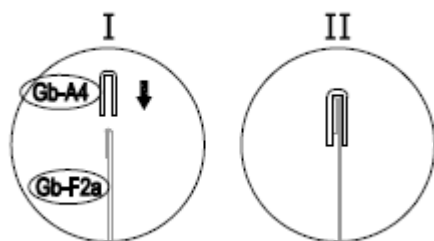

GUARANTEE

IMPORTANT

**Please do not return this product without first calling the Customer Service number below:
0871 911 7031***

Thank you for purchasing this product, which has been made to demanding high quality standards and is guaranteed for domestic use against manufacturing faults for a period of 12 months from the date of purchase.

Register your product for an extended 2-year warranty by visiting our website www.gardengearonline.co.uk. The product must be registered, along with your contact information, within 30 days of purchase. For full terms and conditions please visit our website.

This guarantee does not affect your statutory rights. If your product fails due to a defect in material or workmanship during this period, please return it to the place of purchase. Normal wear and tear is not covered under the guarantee.

Any guarantee is invalid if the product has been misused or subject to neglect or an attempted repair other than by our own service centre. Due to continuous product improvement, we reserve the right to change the product specification without prior notice.

After Sales Customer Service:

Customer Service Department, Branded Garden Products Ltd, Premier House, Hortonwood 7, Telford, TF1 7GP, UK

Telephone: 0871 911 7031*

E-mail customerservice@gardengearonline.co.uk

Please retain for future reference.

Colours and contents may vary.

*Calls cost 13p per minute, plus your phone company's access charge